

AGGWASH™ 300



FEATURES

- Screening, scrubbing, sizing and sand recovery on one modular chassis.
- Up to 300TPH
- Light-weight trash removal
- Quick set-up
- Pre-Piped & Pre-Wired
- Class leading walkaround access for maintenance
- Compact machine footprint



AGGREGATES



RECYCLING



MINING

AggWash™ 300

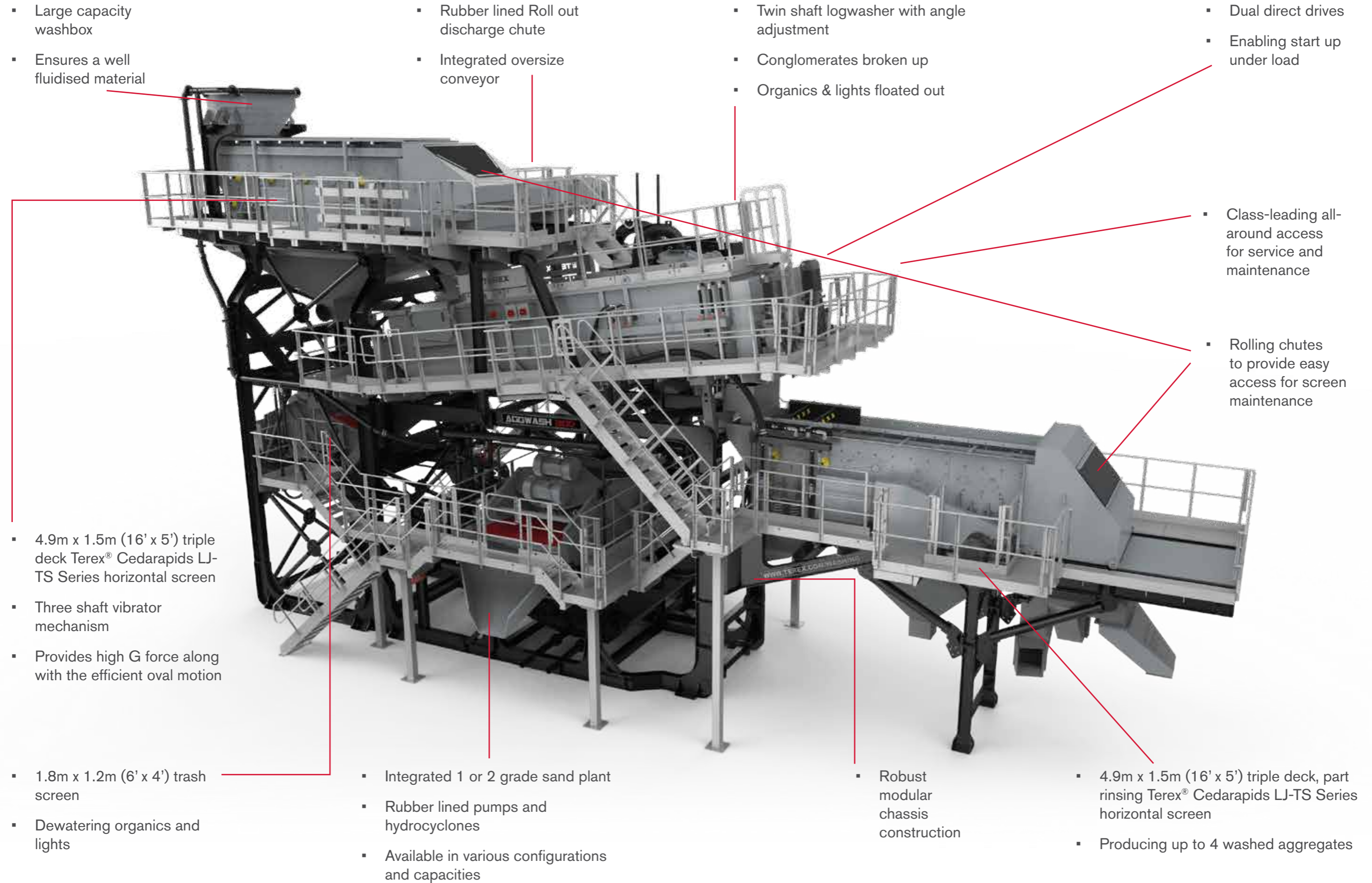

- Large capacity washbox
- Ensures a well fluidised material

- Rubber lined Roll out discharge chute
- Integrated oversize conveyor

- Twin shaft logwasher with angle adjustment
- Conglomerates broken up
- Organics & lights floated out

- Dual direct drives
- Enabling start up under load

- Class-leading all-around access for service and maintenance

- Rolling chutes to provide easy access for screen maintenance

- 4.9m x 1.5m (16' x 5') triple deck Terex® Cedarapids LJ-TS Series horizontal screen
- Three shaft vibrator mechanism
- Provides high G force along with the efficient oval motion

- 1.8m x 1.2m (6' x 4') trash screen
- Dewatering organics and lights

- Integrated 1 or 2 grade sand plant
- Rubber lined pumps and hydrocyclones
- Available in various configurations and capacities

- Robust modular chassis construction

- 4.9m x 1.5m (16' x 5') triple deck, part rinsing Terex® Cedarapids LJ-TS Series horizontal screen
- Producing up to 4 washed aggregates



ADDITIONAL FEATURES AND BENEFITS

- Rubber lined chutes for wear resistance
- Roll-out pump and motor
- Galvanised walkways
- Ring main water inlet complete with gate valves for precise water distribution
- Chute discharge height compatible with deep section lattice frame conveyors for larger stockpiling capacities
- Wash down hose reel (option)
- Inlet water flow meter (option)

PRE-SCREEN

- Large capacity wash box
- TSV5163 full rinser screen box - PU or wire mesh decks
- Variable stroke angle
- Elliptical throw for precise fine aperture screening
- All around walkway access
- 14 isolated spraybars
- Protection deck as standard
- Rubber lined roll out discharge chute complete with integrated oversize conveyor
- Rubber lined discharge chute
- Rubber lined catchbox



SHIPPING REQUIREMENTS

Speak with TWS.Sales@terex.com

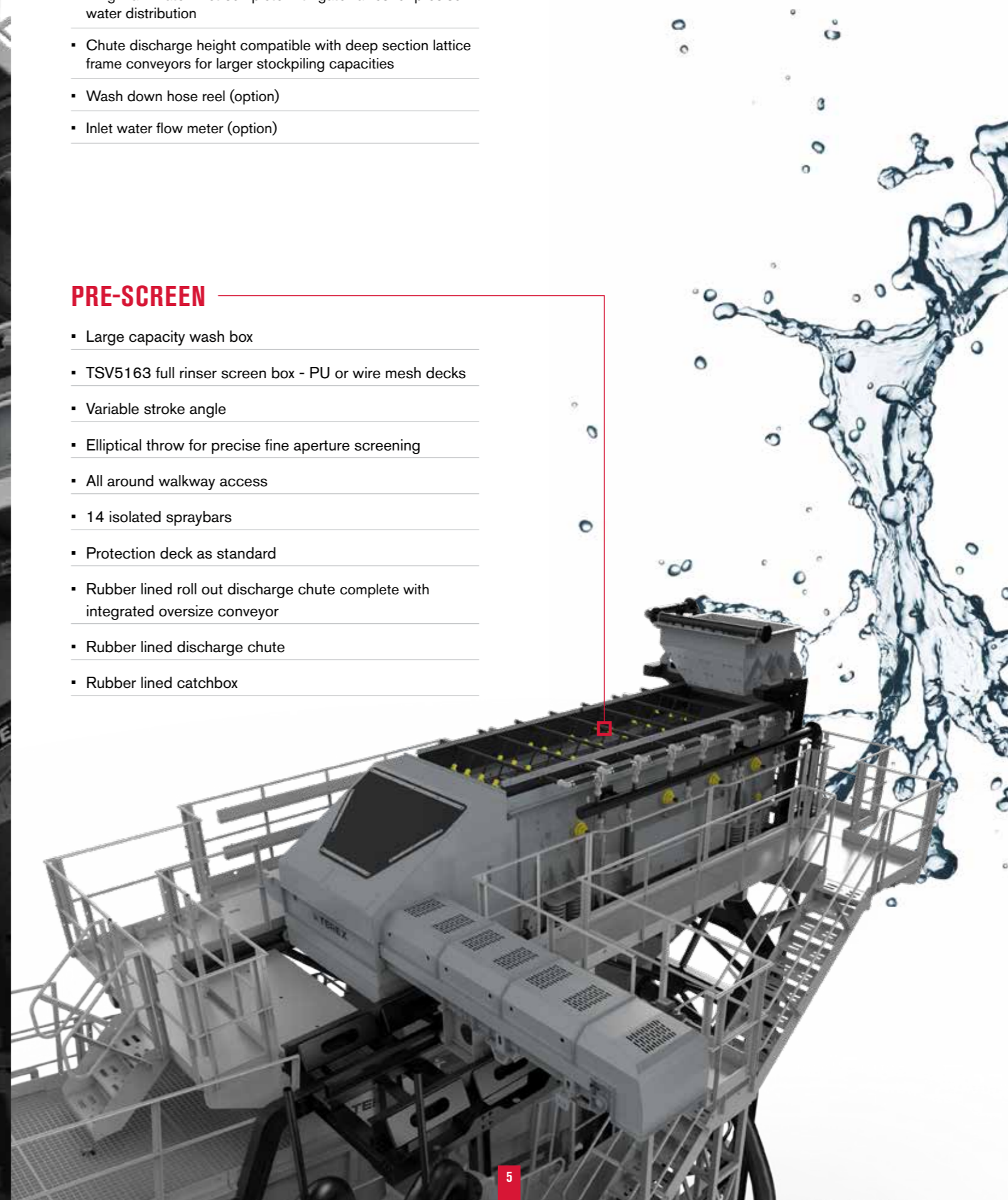

LOGWASHER 200

- All around walkway access
- Hull access doors
- Water flush rear shaft seal complete with inline water filters
- Drive end thrust bearing to protect main radial bearing
- Dual direct drive system for even torque distribution
- Shaft timing maintained through large diameter gears
- Wear sleeve on idle stub shaft
- Rubber lined discharge chutes
- Access to top of hull
- GRP Light weight durable platform

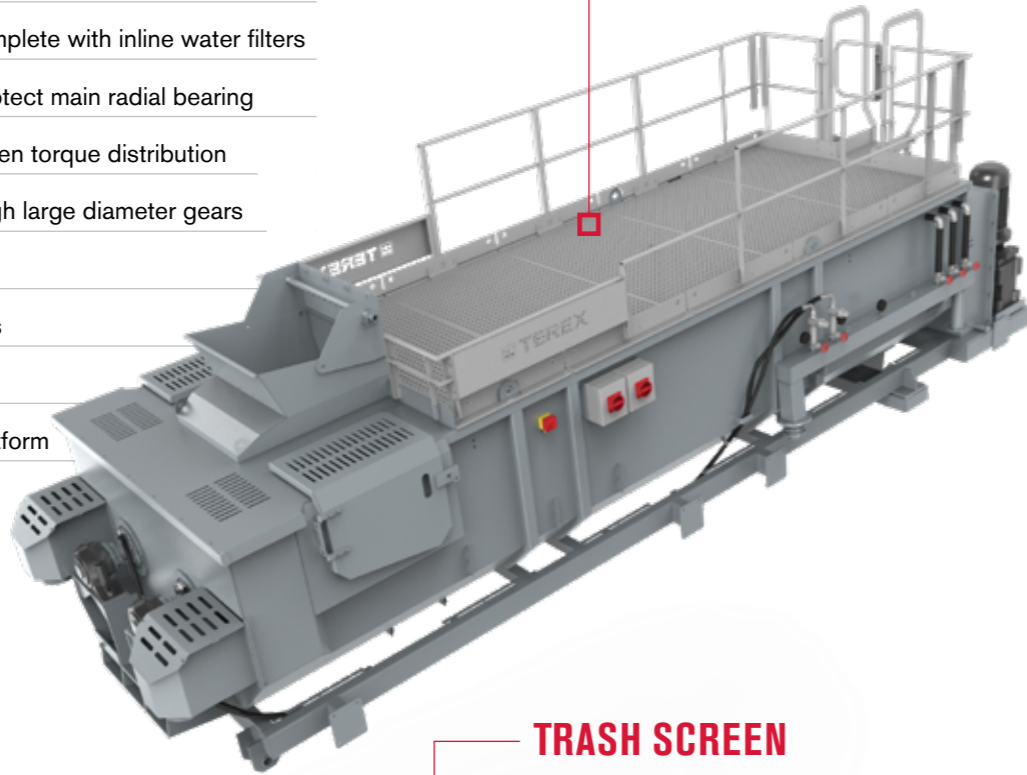

TRASH SCREEN

- High frequency, High g-force 8 x 4 screen
- PU media decks
- Rubber lined catchbox
- Rubber lined discharge chute
- Walkway access

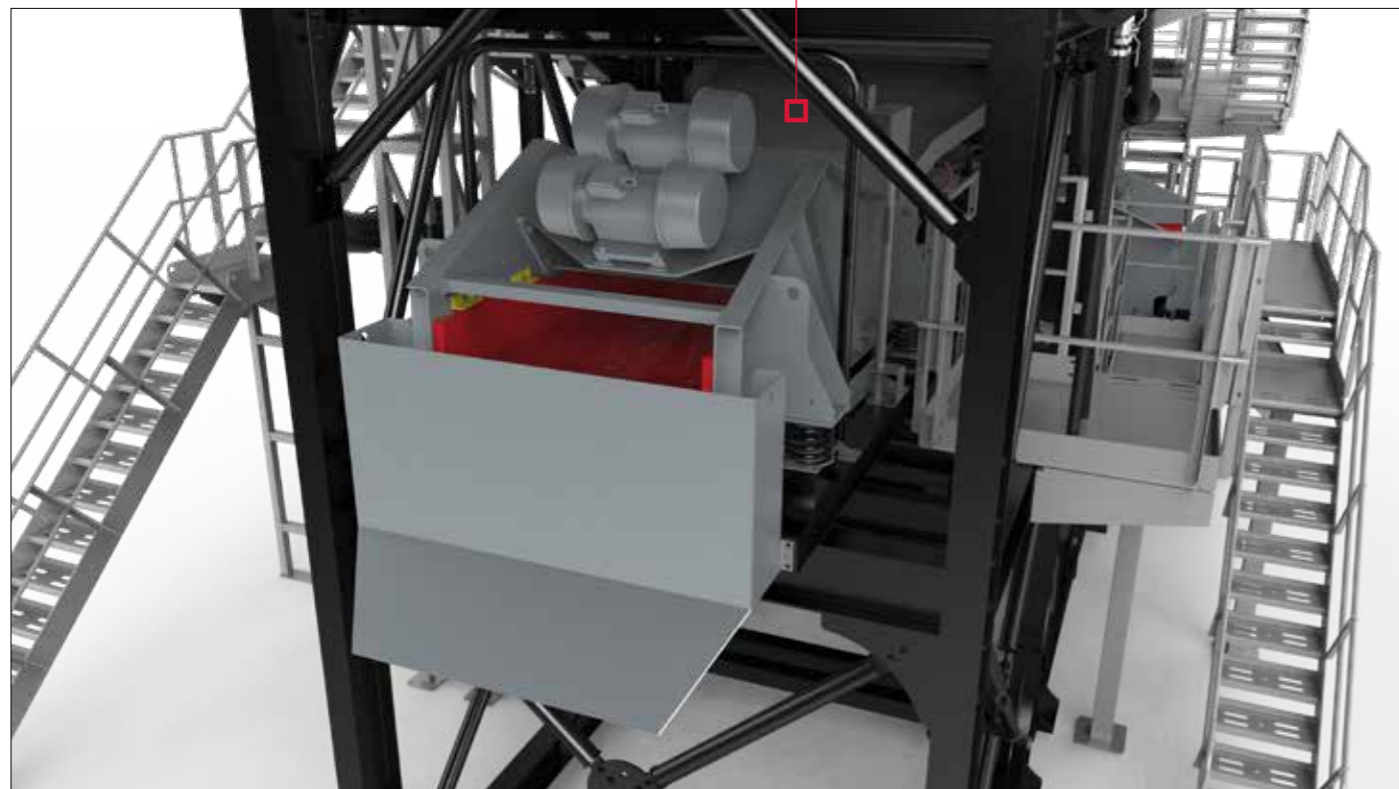

POST-SCREEN

- Elliptical throw for precise fine aperture screening
- TSV5163 part rinser screen box - PU or wire mesh decks
- Variable stroke angle
- 6 isolated spray bars
- Rubber lined catchboxes
- Rubber lined discharge chutes
- Rubber lined Roll out discharge chute
- All around walkway access

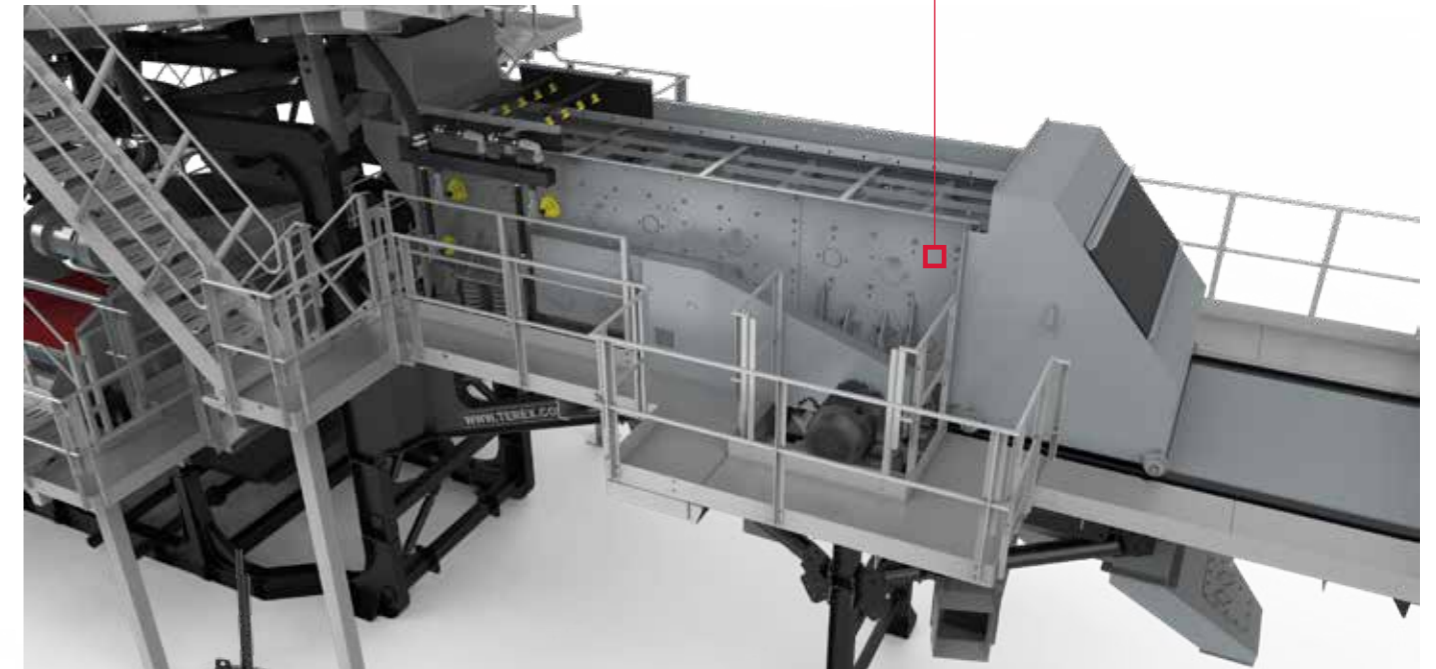

SAND PLANT

- Linatex lined pump and cyclones
- Large variety of cyclone configurations available
- Single or double grade
- Rubber lined components for wear resistance
- High frequency, High g-force 14x6 screen
- lined discharge chute
- PU media decks
- Self regulating tank complete with control valve
- Fresh water top up inlet
- Anti-turbulence box for pump protection
- Roll out pump for ease of maintenance
- Large capacity sump tank
- Sump tank maintenance hatch
- All around walkway access



DIMENSIONS

AGGWASH 300 WORKING DIMENSIONS
PLAN VIEW

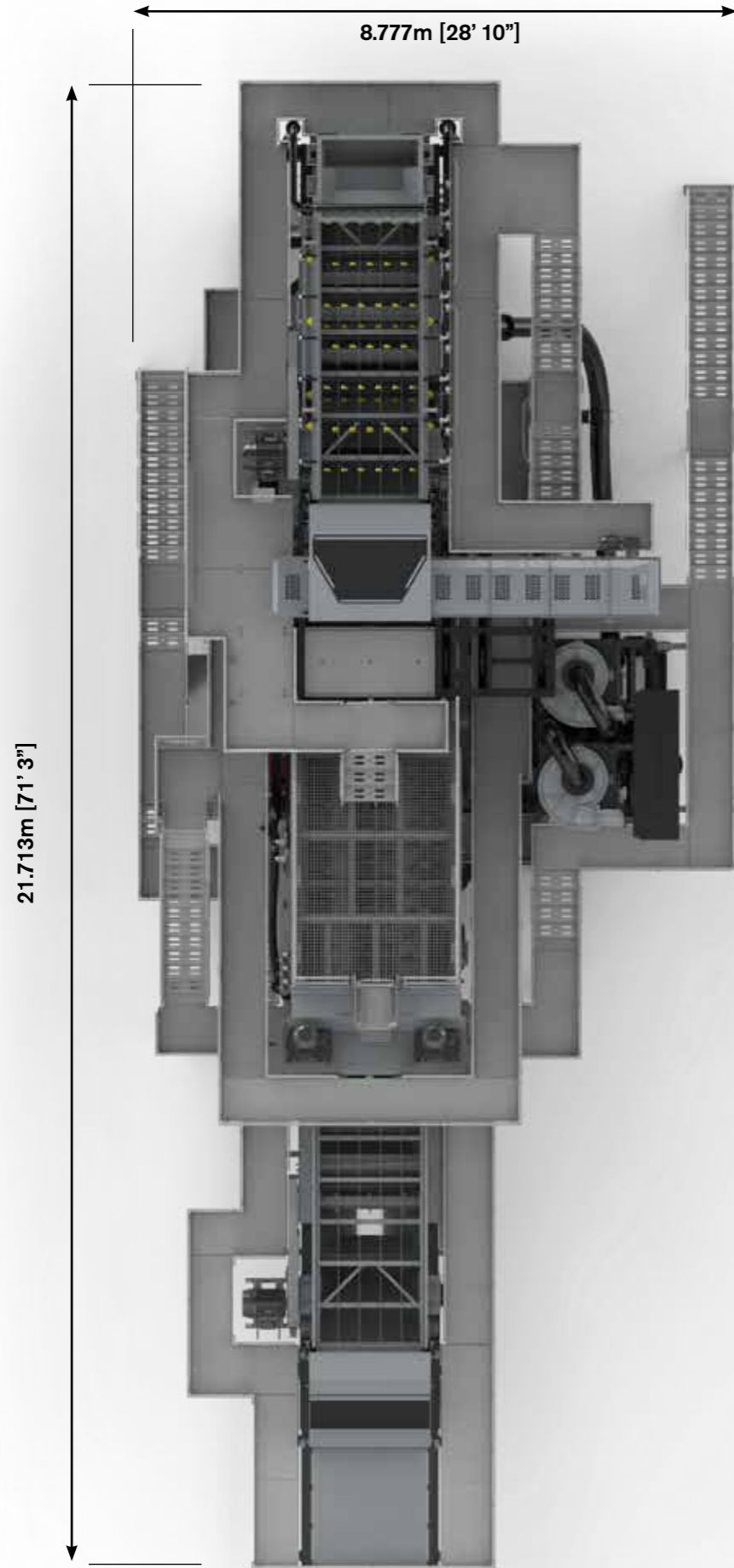

DIMENSIONS

AGGWASH 300 WORKING DIMENSIONS
FRONT ELEVATION

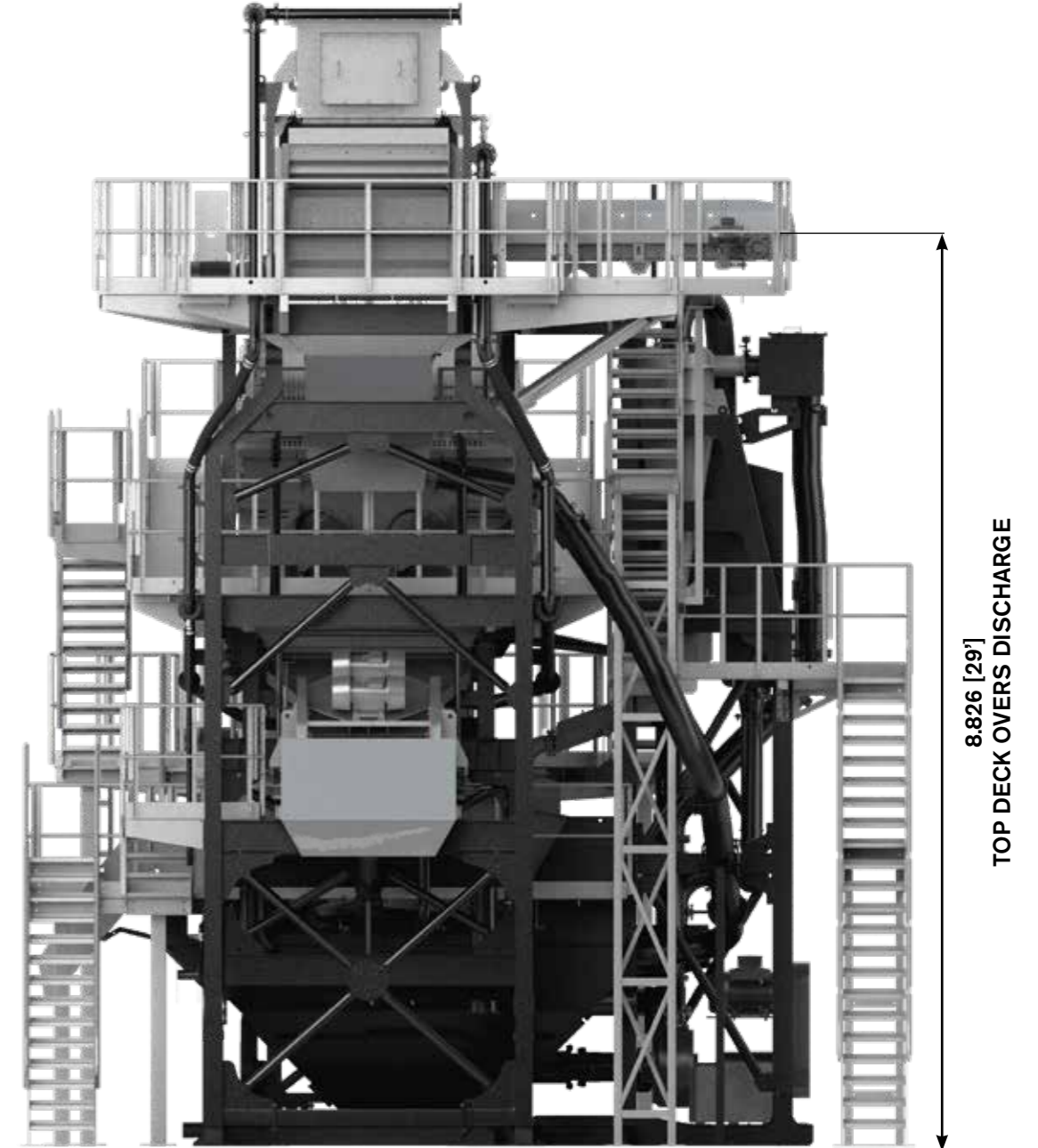

DIMENSIONS

AGGWASH 300 WORKING DIMENSIONS
LEFT ELEVATION

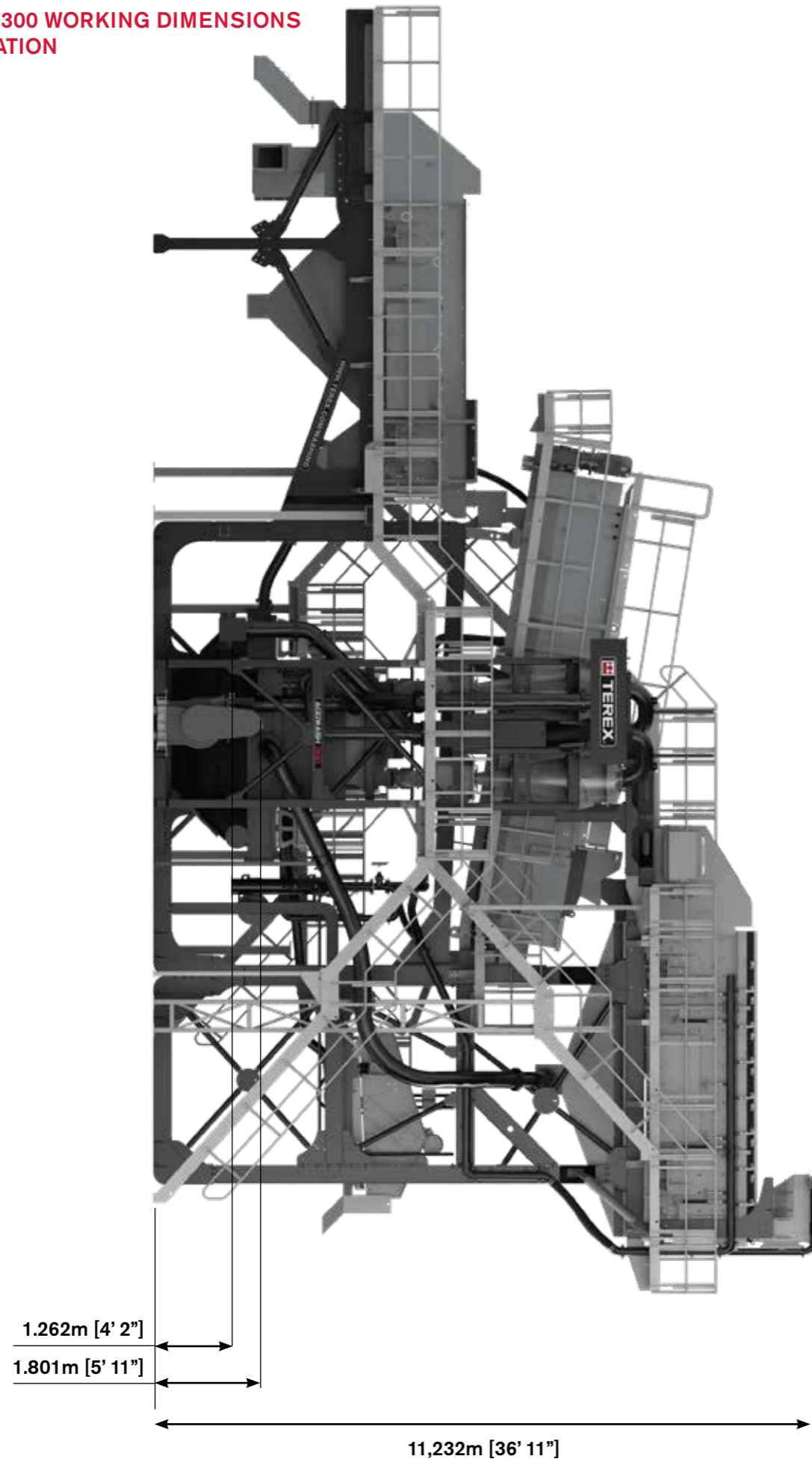

DIMENSIONS

AGGWASH 300 WORKING DIMENSIONS
RIGHT ELEVATION

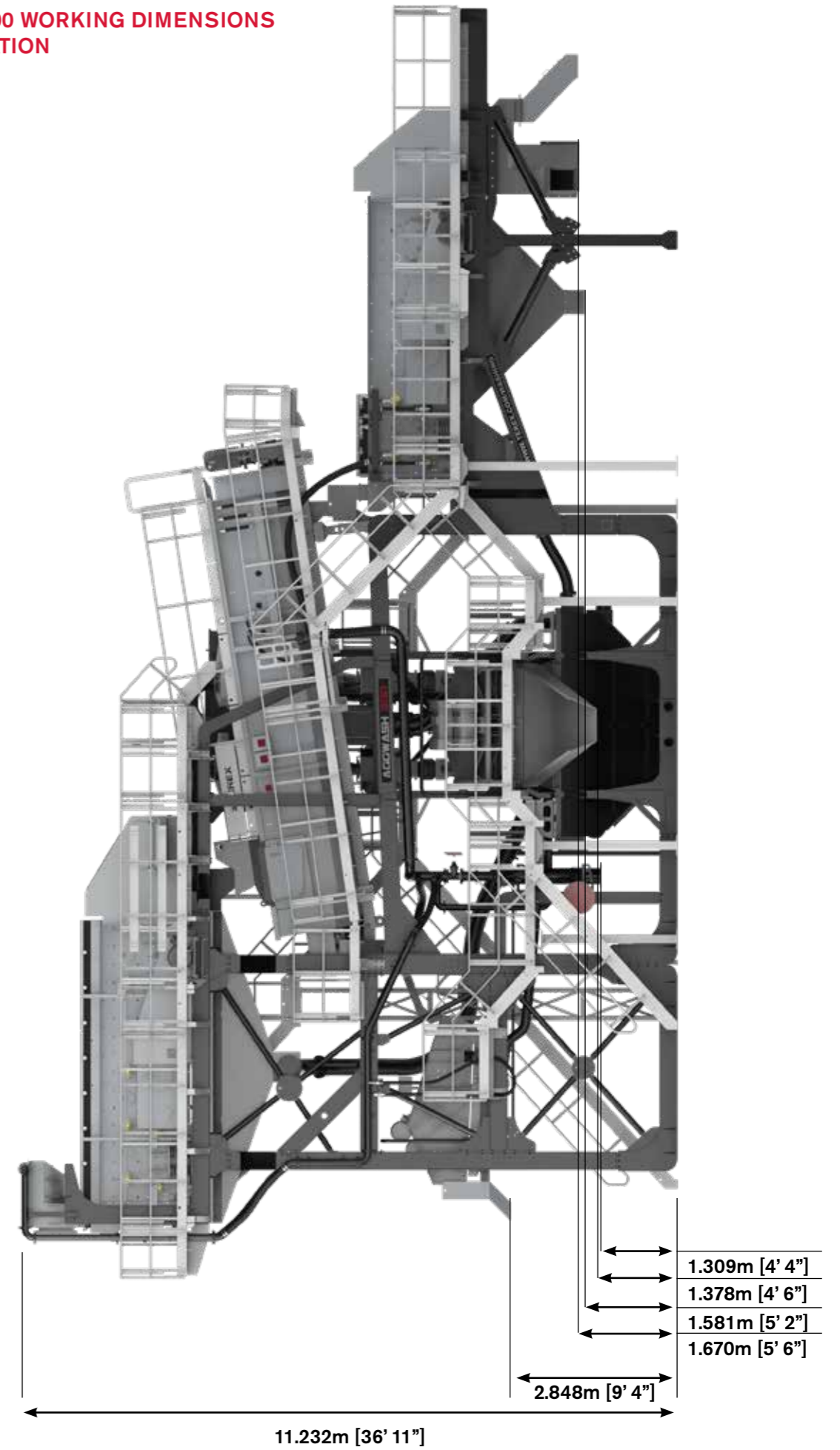



WASHING AS IT SHOULD BE



CHECK OUT TEREX WASHING SYSTEMS
VIDEOS ON YOUTUBE:
www.youtube.com/terexwashingsystems

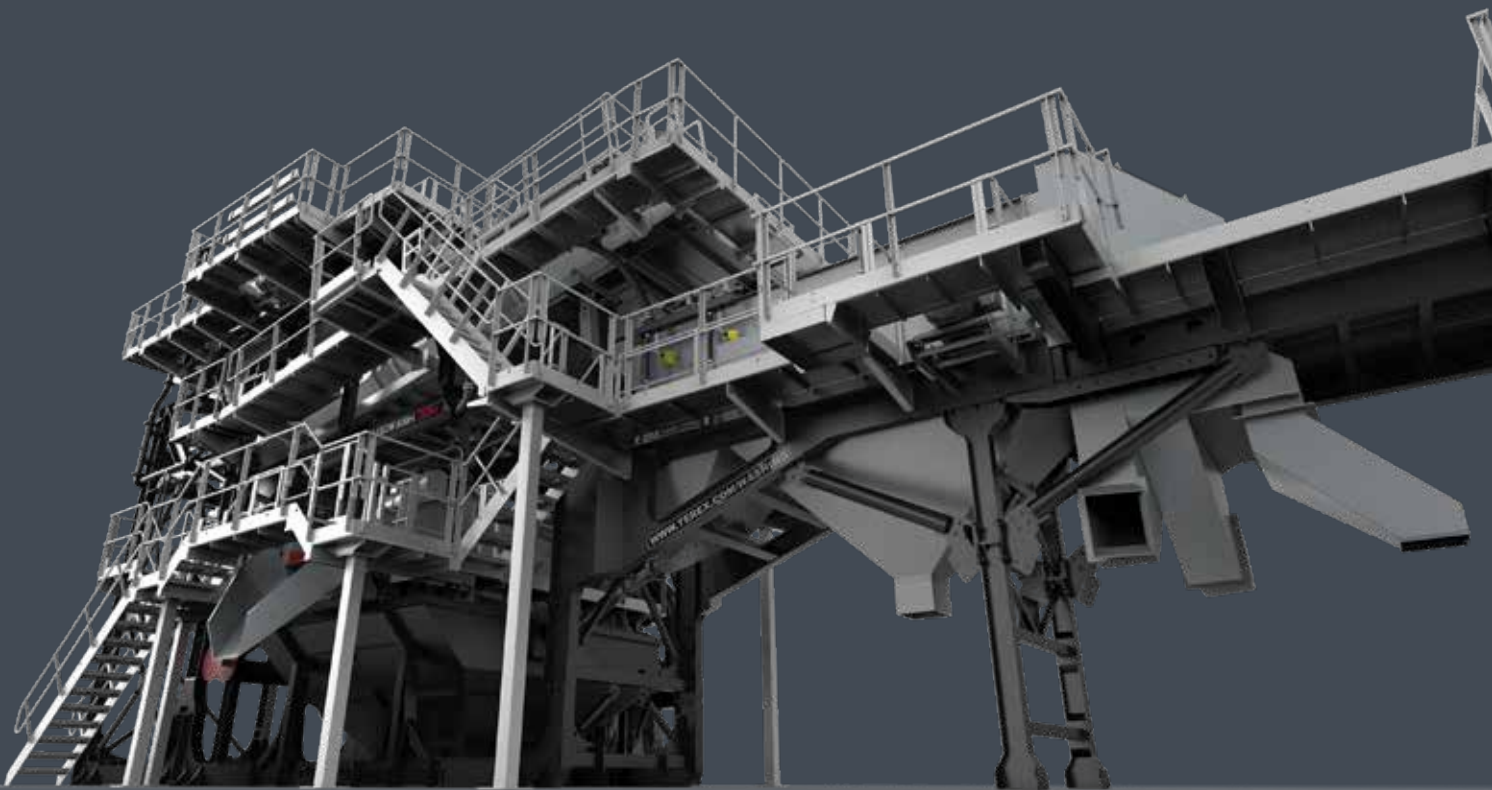

TEREX WASHING SYSTEMS

FARLOUGH SITE

32 Farlough Road,
Dungannon,
Co. Tyrone,
Northern Ireland, BT71 4DT

Tel: +44(0) 28 8771 8500
Email: TWS.sales@terex.com

www.terex.com/washing

Effective Date: June 2022 Product specifications and prices are subject to change without notice or obligation. The photographs and/or drawings in this document are for illustrative purposes only. Refer to the appropriate Operator's Manual for instructions on the proper use of this equipment. Failure to follow the appropriate Operator's Manual when using our equipment or to otherwise act irresponsibly may result in serious injury or death. The only warranty applicable to our equipment is the standard written warranty applicable to the particular product and sale and Terex makes no other warranty, express or implied. Products and services listed may be trademarks, service marks, or trade names of Terex Corporation and/or its subsidiaries in the USA and other countries. All rights are reserved. Terex is a registered trademark of Terex Corporation in the USA and many other countries.
© 2022 Terex Corporation.